



European Metric



US Inch



**Japanese Industrial
Standard Metric**



Super Smart Ball Bushing® Linear Bearings



Super Smart Bushing Linear Bearings

Thomson Super Smart Ball Bushing® bearing advanced technology offers:

- Up to 6 times the load capacity or 216 times the travel life of conventional linear bearings. Permits the up-rating of existing designs.
- Universal self-aligning bearing plates that assure:
 - Forgiveness to misalignment of housing bores and shaft deflection.
 - Uniform ball loading over the entire length of the bearing plate.
 - Optimal distribution of load between ball tracks.
 - Maximum bearing life.
 - Maximum 60 Case shaft life.
- High load capacity that permits cost reduction through the use of smaller and less expensive bearings and 60 Case LinearRace® (shafts).
- Longer travel life when replacing conventional linear bearings, resulting in more flexible planned down time.
- 5 times the LinearRace life compared to conventional and Super Ball Bushing bearings. Maintains bearing/60 Case shaft fit-up longer by minimizing wear.
- Super Smart bearings contain universally self-aligning bearing plates, which eliminates the need for derating factors commonly required for linear guides.
- Steady state speeds up to 3 m/s and accelerations up to 150 m/s².
- Lowest coefficients of friction in the industry! As low as .0001.
- Double lip integral wipers which keep dirt and grit out, while keeping lubrication in. Maximizes bearing life.
- The use of smaller less expensive drive motors, belts, gears, and ball screws, when replacing high-friction, plain bushings.

Super Smart Ball Bushing Linear Bearings

Super Smart Ball Bushing bearings represent a breakthrough in linear motion technology.

High Load Capacity/ Long Life

Super Smart Ball Bushing bearings provide up to 6 times more load capacity or 216 times more travel life than conventional linear bearings (see Charts 1 and 2).

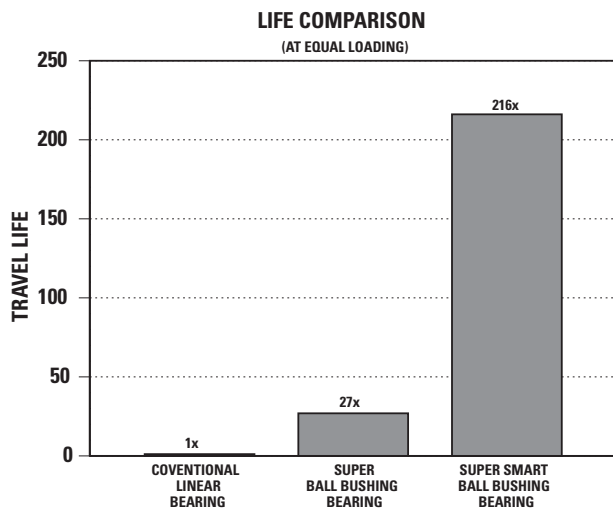
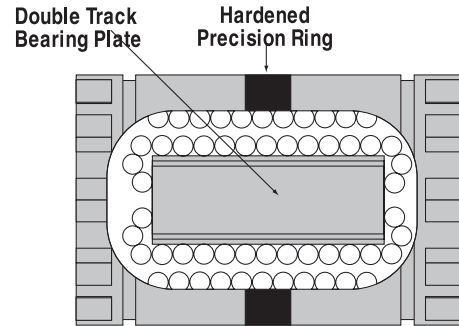

Chart 1

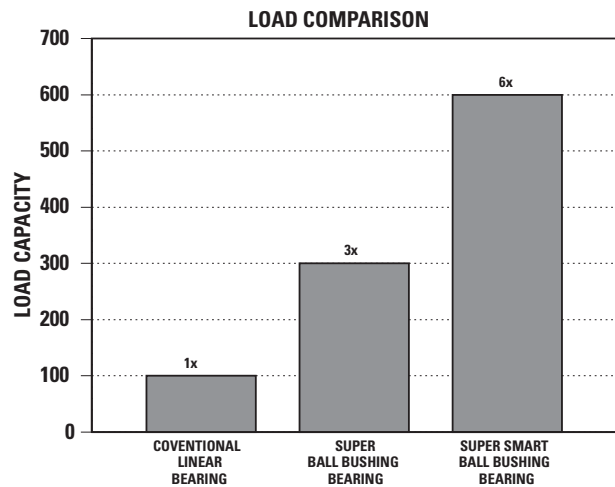

Chart 2

RoundRail Advantage

The inherent ability of a RoundRail Ball Bushing bearing to accommodate torsional misalignment (caused by inaccuracies in carriage or base machining or machine deflection) with little increase in stress to the bearing components.

Adjustable Bearing/ LinearRace Fit-Up

When the Super Smart Ball Bushing bearing is mounted in an adjustable housing, selected preload can be achieved. The bearing is designed to allow the bearing plates to move radially. This provides the ability to achieve close bearing/ LinearRace fit-ups for high precision applications.

The high load capacity is the result of adding extra ball tracks and optimally positioning the double track bearing plates. This places the maximum number of load bearing balls in the load zone (see figure 1).

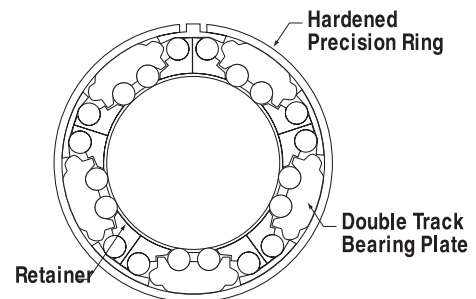

Figure 1

Cross-section of Super Smart Ball Bushing Bearing



Super Smart Ball Bushing Linear Bearings

Universal Self-Aligning

The universal self-aligning features of the Super Smart Ball Bushing bearing provide smooth operation and a constant low coefficient of friction; In addition, these features maximize bearing life.

- (1) The bearing plate is designed with the radius of its outer surface smaller than that of the inside radius of the hardened precision ring. This allows the bearing plate to roll against the ring, evenly distributing the load on each of its two ball tracks (see Figure 2).

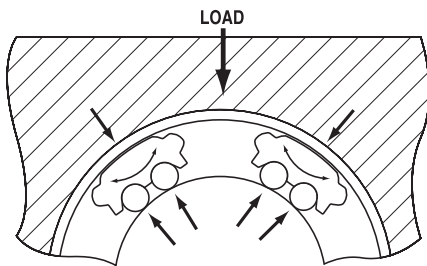

Figure 2

Close-up of double track bearing plates showing how they self-align (roll) to evenly distribute the load on each of their two ball tracks.

- (2) The bearing is also designed to allow the bearing plates to rock 0.5° about the hardened precision ring to assure smooth ball entry and exit in the load carrying zone and optimum ball loading from end to end (see Figure 3 and 4).

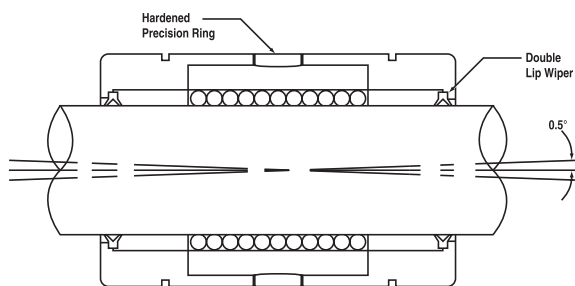

Figure 3

Pitch self-alignment compensates for misaligned housing bores and LinearRace deflection.

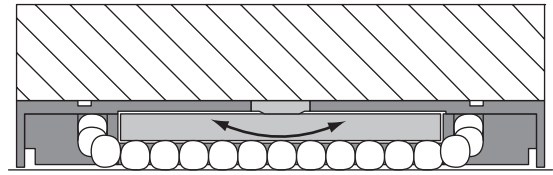

Figure 4

Close-up of hardened precision ring, showing how the bearing plate self-aligns (rocks) about the curved surface of the ring.

- (3) The bearing plate is also able to rotate about its center. This prevents skewing of the ball tracks relative to the LinearRace which minimizes friction and maximizes bearing life (see Figure 5).

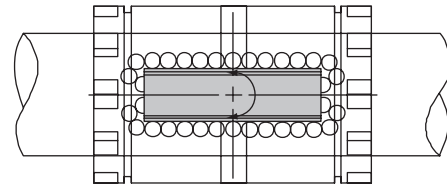

Figure 5

Bearing plates rotate about their center to prevent skewing relative to the 60 Case LinearRace shaft.

Long Lasting Bearing/ Shaft Fit-Up

The bearing's hardened precision ring provides a hard surface to back the bearing plates. The Super Smart Ball Bushing bearing maintains its bearing/ LinearRace fit-up even when installed in soft metal or non-metallic housings.

Ball Bushing Bearing Life Expectancy and Load Capacity

Load Capacity

The load ratings given in the tables apply to Super Smart Ball Bushing bearings in conjunction with a 60 Case LinearRace.

1. The load is applied as shown on Charts, 6 and 7.
2. LinearRace hardness is HRC 60 to 65.
3. Travel life of 50 km.

For configurations other than those described above, the follow formula is used:

$$C_R = \frac{P}{K_\theta \cdot K_S \cdot K_L}$$

where:

- C_R = required dynamic load capacity (kgf)
- P = resultant of externally applied loads (kgf)
- K_θ = factor for direction of resultant load, refer to polar graphs
- K_S = shaft hardness factor
- K_L = travel life factor

Load Direction

In applications where the direction of the resultant load is known, refer to the polar graphs for the load correction factor, K_θ . If the direction of the resultant load is unknown, use a load correction factor, K_θ of 0.73.

Hardness

For shafts which do not meet LinearRace hardness specifications, shaft hardness factor K_S must be applied (see Figure 6).

Travel Life

The travel life correction factors, K_L can be found on Figure 7

Dynamic Load Rating

The dynamic load rating is the maximum continuous load that can be applied to the bearing with a 90% reliability of achieving life of 50 km under conventional operating conditions. However, it is important to remember that very short strokes and the direction of the applied load can be significant factors. Contact factory for details.

The following formula may be used to determine travel life.

$$L_m = \left(\frac{C}{P} \cdot K_\theta \cdot K_S \right)^3 \cdot 50 \text{ km}$$

where:

- L_m = travel life (km)
- C = dynamic load ratings (kgf)
- P = resultant of externally applied load (kgf)
- K_θ = factor for direction of resultant load
- K_S = shaft hardness factor

Figure 6

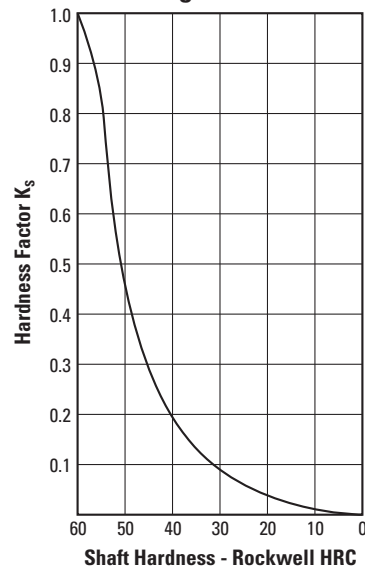
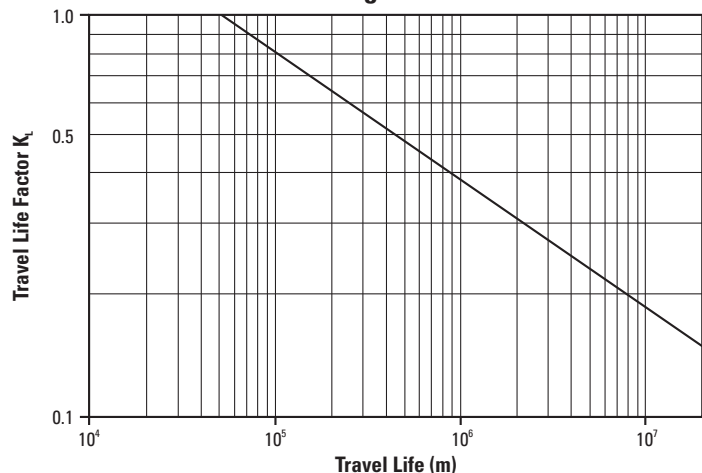
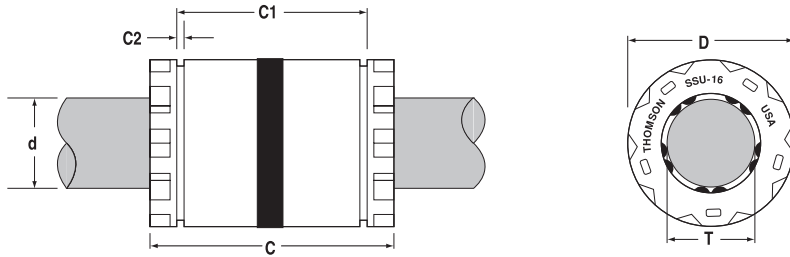
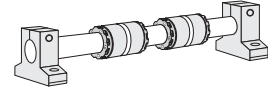

Figure 7





Super Smart Ball Bushing Bearings (Closed Type) for End Supported Applications



Super Smart Ball Bushing Bearings (Closed Type)

	Part Number			60 Case Linear Race Diameter d	Recommended Housing Bore Fixed D	Length C	C1	C2 min.	Number of Ball Circuits	Ball Bushing bearing Mass lb	Dynamic (1) Load Capacity (2) lbf or N
	Without Integral Wipers	With one Integral Wiper	With two Integral Wipers								
INCH	SS6U 8	SS6U 8 W	SS6U 8 WW	1/2 L	.8755/.8750	1.250/1.230	1.032/1.012	.050	6	.07	265
	SSU 10	SSU 10 W	SSU 10 WW	5/8 L	1.1255/1.1250	1.500/1.480	1.125/1.095	.055	10	.12	620
	SSU 12	SSU 12 W	SSU 12 WW	3/4 L	1.2505/1.2500	1.625/1.605	1.285/1.255	.055	10	.16	1130
	SSU 16	SSU 16 W	SSU 16 WW	1 L	1.5630/1.5625	2.250/2.230	1.901/1.871	.068	10	.29	1900
	SSU 20	SSU 20 W	SSU 20 WW	1 1/4 L	2.0008/2.0000	2.625/2.600	2.031/1.991	.068	10	.52	2350
	SSU 24	SSU 24 W	SSU 24 WW	1 1/2 L	2.3760/2.3750	3.000/2.970	2.442/2.402	.086	10	.99	3880
EU METRIC	SSE M16	SSE M16 W	SSE M16 WW	16	26	36	24,6	1,30	10	0,030	2200
	SSE M20	SSE M20 W	SSE M20 WW	20	32	45	31,2	1,60	10	0,066	4000
	SSE M25	SSE M25 W	SSE M25 WW	25	40	58	43,7	1,85	10	0,135	6700
	SSE M30	SSE M30 W	SSE M30 WW	30	47	68	51,7	1,85	10	0,206	8300
	SSE M40	SSE M40 W	SSE M40 WW	40	62	80	60,3	2,15	10	0,392	13700
JIS METRIC	SSJM 16	SSJM 16 W	SSJM 16 WW	16	28	37	26.5	1.60	10	.030	2200
	SSJM 20	SSJM 20 W	SSJM 20 WW	20	32	42	30.5	1.60	10	.066	4000
	SSJM 25	SSJM 25 W	SSJM 25 WW	25	40	59	41	1.85	10	.133	6700
	SSJM 30	SSJM 30 W	SSJM 30 WW	30	45	64	44.5	1.85	10	.202	8300
	SSJM 40	SSJM 40 W	SSJM 40 WW	40	60	80	60.5	2.10	10	.392	13700

(1) The Dynamic Load Capacity is based on a rated travel life of 2 million inches (100 km for metric bearings). The actual Dynamic Load Capacity can be affected by the orientation of the bearing or the direction of the applied load. For dynamic load correction factors see polar graphs below.
 (2) lbf is used for inch products, N for metric products. All dimensions are in inch for inch products, and mm for metric products.

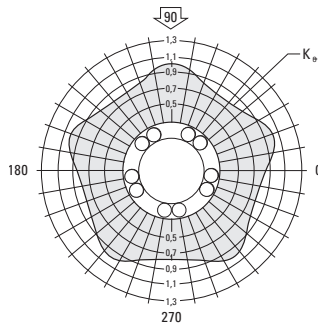

SSE M16
 SSE M20
 SSE M25
 SSE M30
 SSE M40

Super Smart Ball Bushing Bearings (Open Type) for Continuously Supported Applications

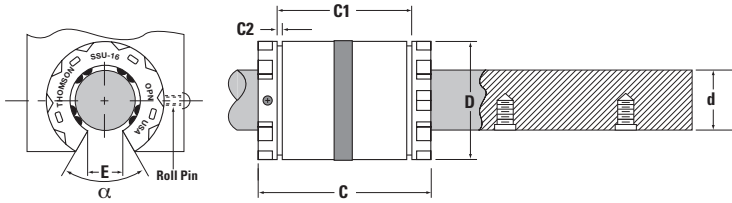
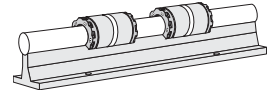

Super Smart Ball Bushing Bearings (Open Type) and 60 Case LinearRace Shafting (Dimensions in inches)

	Part Number			60 Case LinearRace Diameter d	Recommended Housing Bore Dia.	Length C	C1	C2 min.	Angle deg α	Number of Ball Circuits	Dynamic Load Capacity lb _f (±)
	Without Integral Wipers	With one Integral Wiper	With two Integral Wipers		Fixed D						
INCH	SSU 8 OPN	SSU 8 OPN W	SSU 8 OPN WW	1/2 L PD	.8755/.8750	1.250/1.230	1.032/1.012	.050	90	6	360
	SSU 10 OPN	SSU 10 OPN W	SSU 10 OPN WW	5/8 L PD	1.1255/1.1250	1.500/1.480	1.125/1.095	.055	60	8	620
	SSU 12 OPN	SSU 12 OPN W	SSU 12 OPN WW	3/4 L PD	1.2505/1.2500	1.625/1.605	1.285/1.255	.055	60	8	1130
	SSU 16 OPN	SSU 16 OPN W	SSU 16 OPN WW	1 L PD	1.5630/1.5625	2.250/2.230	1.901/1.871	.068	60	8	1900
	SSU 20 OPN	SSU 20 OPN W	SSU 20 OPN WW	1 1/4 L PD	2.0008/2.0000	2.625/2.600	2.031/1.991	.068	50	8	2350
	SSU 24 OPN	SSU 24 OPN W	SSU 24 OPN WW	1 1/2 L PD	2.3760/2.3750	3.000/2.970	2.442/2.402	.086	50	8	3880
EU METRIC	SSE M16 OPN	SSE M16 OPN W	SSE M16 OPN WW	16	26	36	24,6	1,30	70	8	2200
	SSE M20 OPN	SSE M20 OPN W	SSE M20 OPN WW	20	32	45	31,2	1,60	50	8	4000
	SSE M25 OPN	SSE M25 OPN W	SSE M25 OPN WW	25	40	58	43,7	1,85	60	8	6700
	SSE M30 OPN	SSE M30 OPN W	SSE M30 OPN WW	30	47	68	51,7	1,85	55	8	8300
	SSE M40 OPN	SSE M40 OPN W	SSE M40 OPN WW	40	62	80	60,3	2,15	54	8	13700
JIS METRIC	SSJM 16 OPN	SSJM 16 OPN W	SSJM 16 OPN WW	16	28	37	26,5	1,60	80	8	2200
	SSJM 20 OPN	SSJM 20 OPN W	SSJM 20 OPN WW	20	32	42	30,5	1,60	60	8	4000
	SSJM 25 OPN	SSJM 25 OPN W	SSJM 25 OPN WW	25	40	59	41	1,85	50	8	6700
	SSJM 30 OPN	SSJM 30 OPN W	SSJM 30 OPN WW	30	45	64	44,5	1,85	50	8	8300
	SSJM 40 OPN	SSJM 40 OPN W	SSJM 40 OPN WW	40	60	80	60,5	2,10	50	8	13700

(††) The Dynamic Load Capacity is based on a rated travel life of 2 million inches (100 km for metric bearings). The actual Dynamic Load Capacity can be affected by the orientation of the bearing or the direction of the applied load. For dynamic load correction factors see polar graphs to the right.

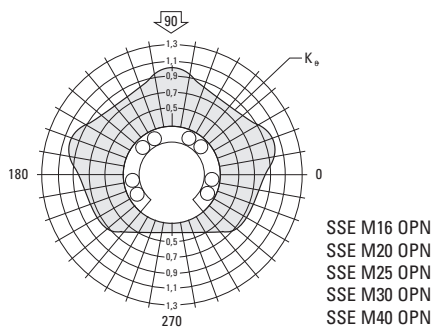

Contact us or any of our 2000+ global distribution partners by scanning the code below
or visiting www.thomsonlinear.com/contact



RegalRexnord™

www.regalrexnord.com

www.thomsonlinear.com

Super_Smart_Ball_Bushing_Bearings_BREN-0004-02 | 20260217TJ | MCB-12409-TL-EN-US 02/26
Specifications are subject to change without notice. It is the responsibility of the product user to determine
the suitability of this product for a specific application. All trademarks property of their respective owners.
©2026 Thomson Industries, Inc. | 2400 Curtiss Street, Downers Grove, IL 60515 USA

THOMSON®